

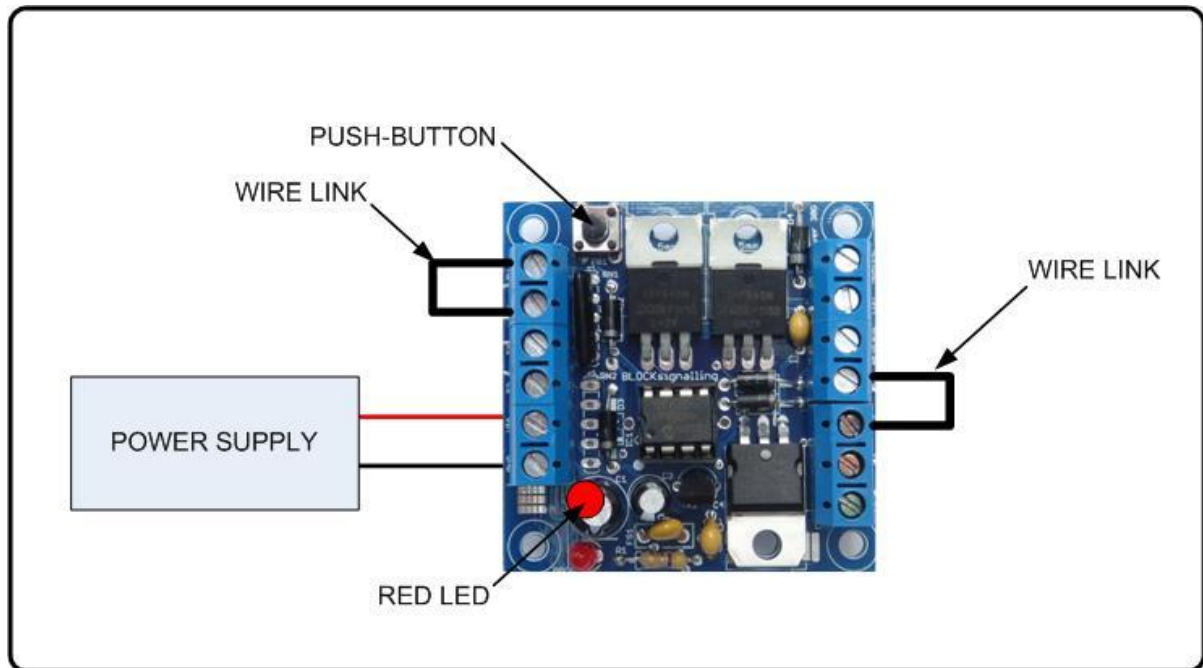

## Programming Procedure

The module is programmable, and many of the settings can be adjusted to suit. Programming is performed by holding down the Push Button when switching on the power.

Details of the programming options are given towards the end of this page.



When programming, there are two values to be entered.

The red led on the PCB flashes at 1 second intervals. When the required number of flashes is seen (see later for the list of possible choices) the button is released to store the first value. At this point the led comes on for five seconds to confirm the first value is stored.

The led then starts flashing again, and this time the button needs to be pressed to store the second value.

Now the two values to be stored have been entered, the led flashes 10 times rapidly, and the module starts operating.

Each value entered can range between 1 and 255. If more flashes are seen, or the programming is aborted by switching off, then the programming must be repeated.

## **Factory Reset**

To reset the module back to factory settings, switch off the power to the module and hold down the Push Button. Apply the power and continue holding the push button until 1 flash of the led is seen. At this point, release the button. You will see a long flash of five seconds.

The led will begin flashing again. When you have seen 1 flash press the button. You will see a long flash of five seconds and then 10 rapid flashes. The reset procedure is then complete and the module will restart running a test program. This operates the points between normal and reverse running at 1 second intervals. This can be used to confirm the wiring to the points is correct, as it operates the points without needing the infra-red sensors needing to be connected.

If you make a mistake programming, simply repeat the process.

## **Sensitivity Setting**

The module is supplied with the sensitivity pre-set to suit most installations and should not need adjustment.

In locations such as tunnels, or when the module is not being used under the track bed, then it may be desirable to adjust the detection threshold.

The sensitivity is factory set to 5, and can be adjusted from 1 to 10 (with 1 being the most sensitive and 10 being the least sensitive).

To change the sensitivity, switch off the power to the module and hold down the Push Button. Apply the power and continue holding the Push Button until 9 flashes of the led are seen. At this point, release the button. You will see a long flash of five seconds.

The led will begin flashing again. When you have reached the desired number of flashes to set the new sensitivity, press the button. You will see a long flash of five seconds and then 10 rapid flashes. The programming is then complete and the module will restart. If you make a mistake programming, simply repeat the process.

Performing a factory reset will reset the sensitivity setting back to 5.

## Testing the Infra-red Detection

An Infra-Red source and Infra-Red detector are moulded into a single 5mm x 6.5mm package that can be located below the track bed to reflect light off rolling stock.

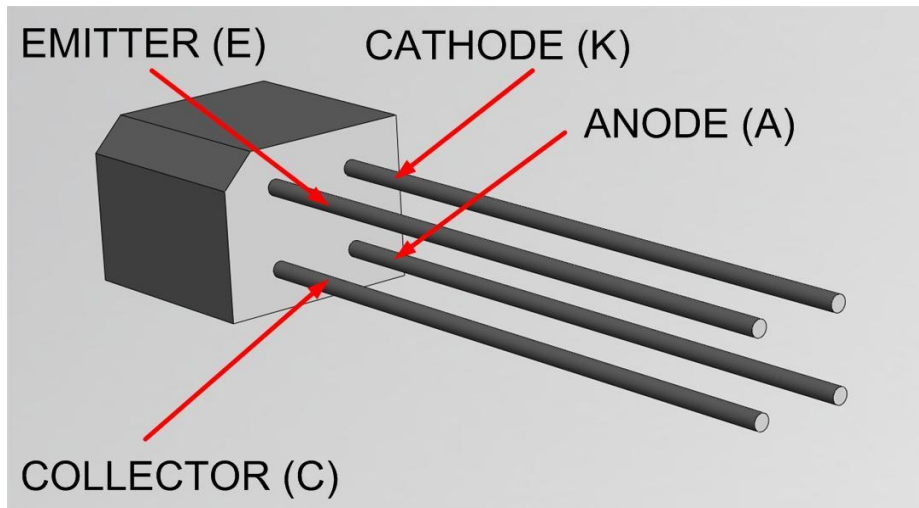

Identify the leads from the diagram below and connect to the terminals marked A1, K1, C1 and E1 on the PCB for sensor 1 (for sensor 2, use A2, K2, C2 and E2).

The wires can be extended using small chocolate block and extra lengths of cable if required (not supplied).

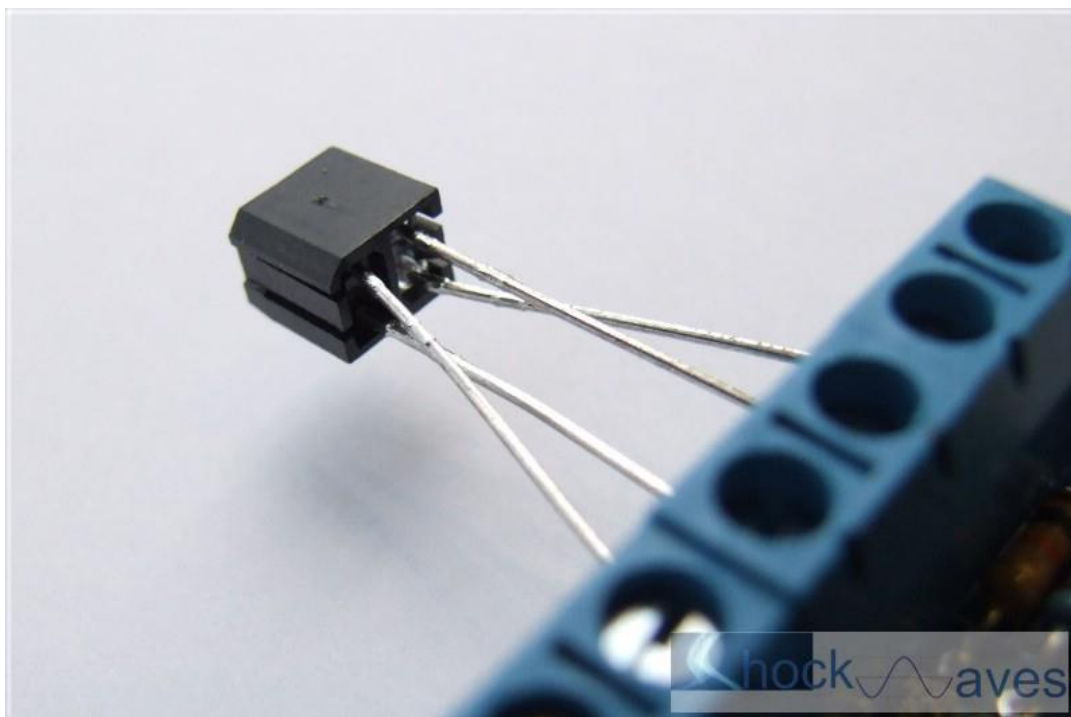

## Installation

The Infra-Red sensors are normally installed below the track-bed. The detection range of the unit is up to approximately 25mm from the face of the package when normal sensitivity is set (for dark surfaces with low levels of reflectivity).

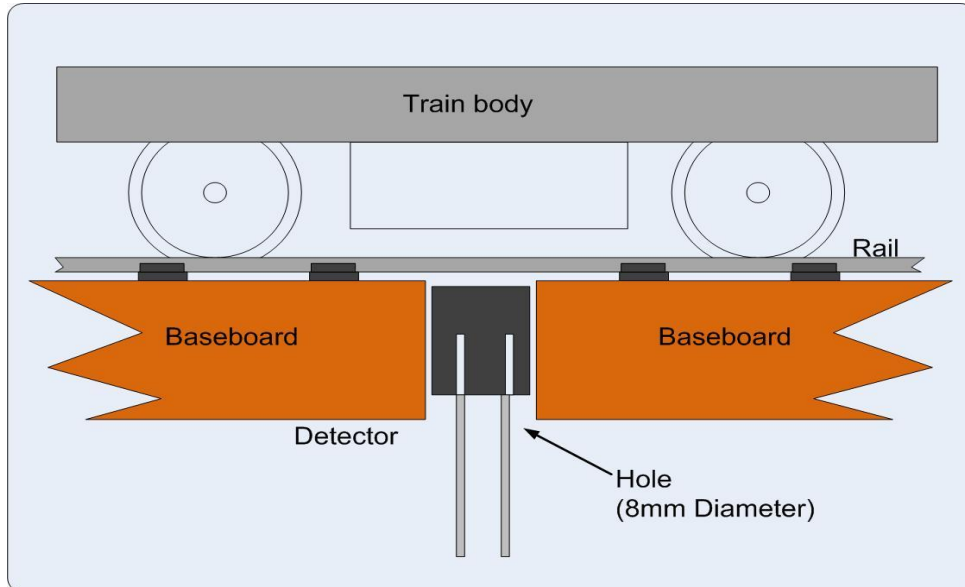

The detectors can be mounted in an 8mm hole drilled through the track baseboard. If required, the detectors can be held in place using a small amount of blutack, expanded polystyrene or similar.

The led diameter is 2.2mm, so on smaller scales the leds can still have a clear view between the sleepers.

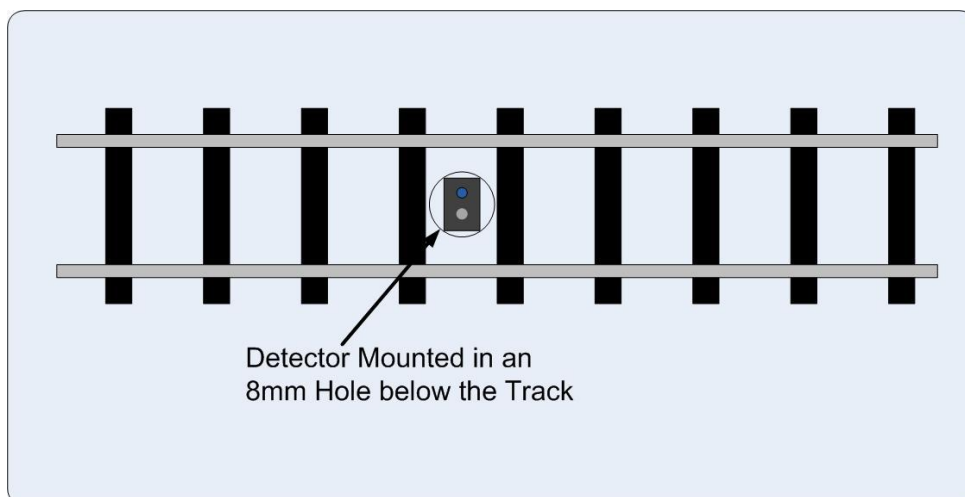

# Operation with Trailing Points

The points controller uses the two sensors under the main and branch lines to sense the presence of approaching trains.

When a train is detected on either line, the points are automatically operated to select that line.

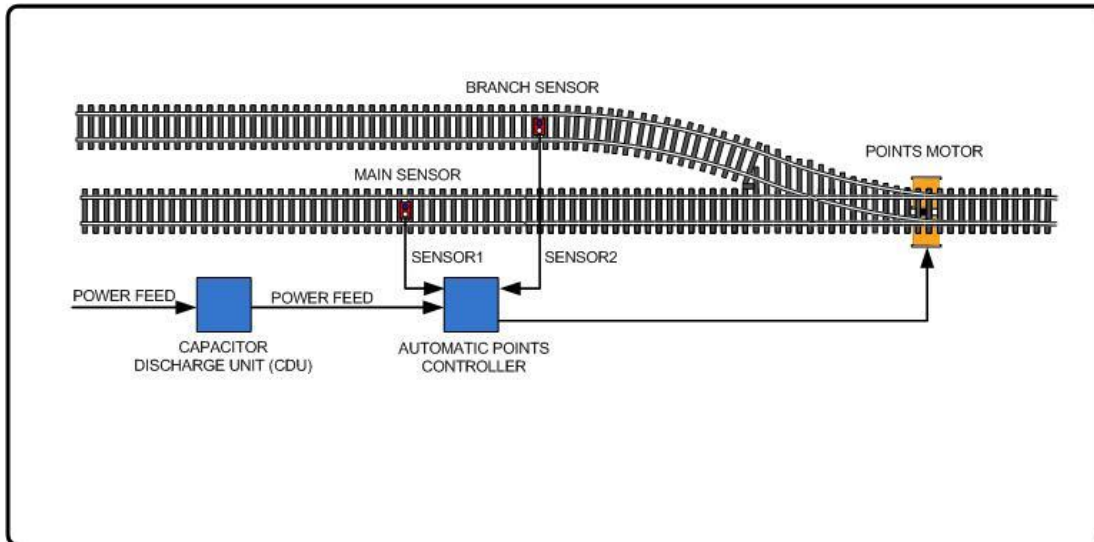

If multiple branch lines are used, in goods yards for instance, then a number of points controllers can be used to automatically route trains from the sidings to the main line.

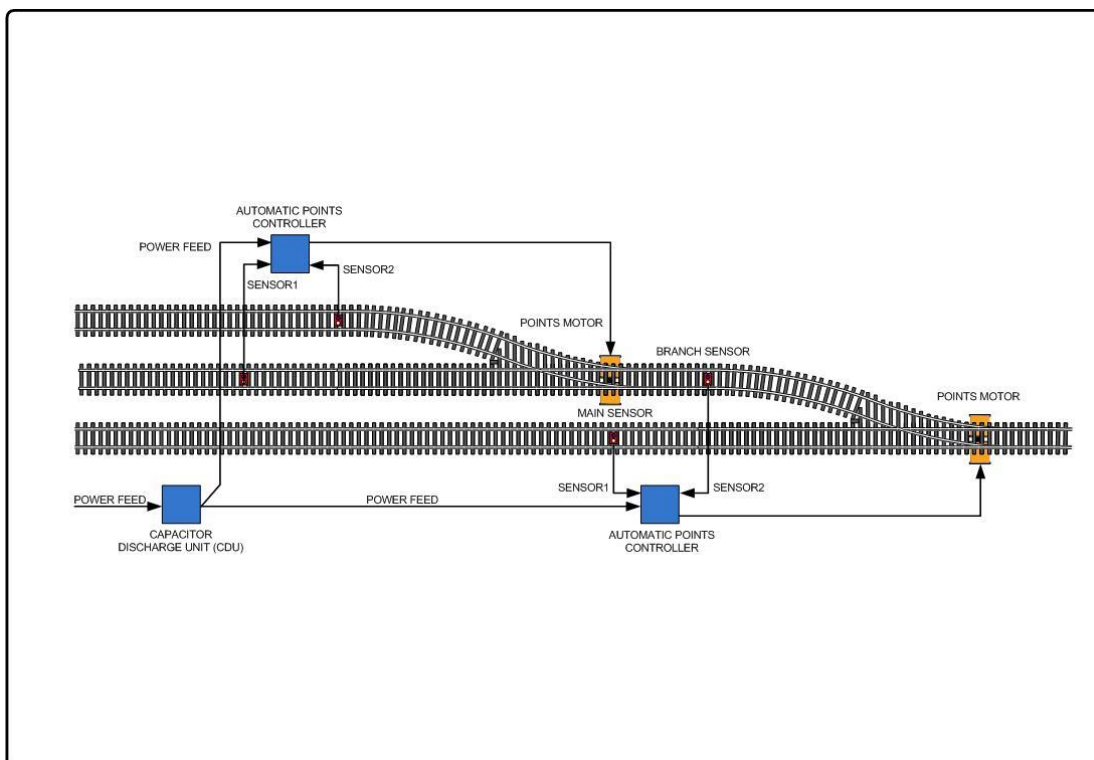

## Operation with Facing Points

Facing points diverge in two directions for approaching trains.

The points controller is able to detect trains approaching the points and, depending on the programming, will send trains to the branch line.

By programming the ratio (see later), you can select whether one in every 2, one in every 3, etc trains run to the branch line.

It is also possible to randomly set trains to run to the branch line.

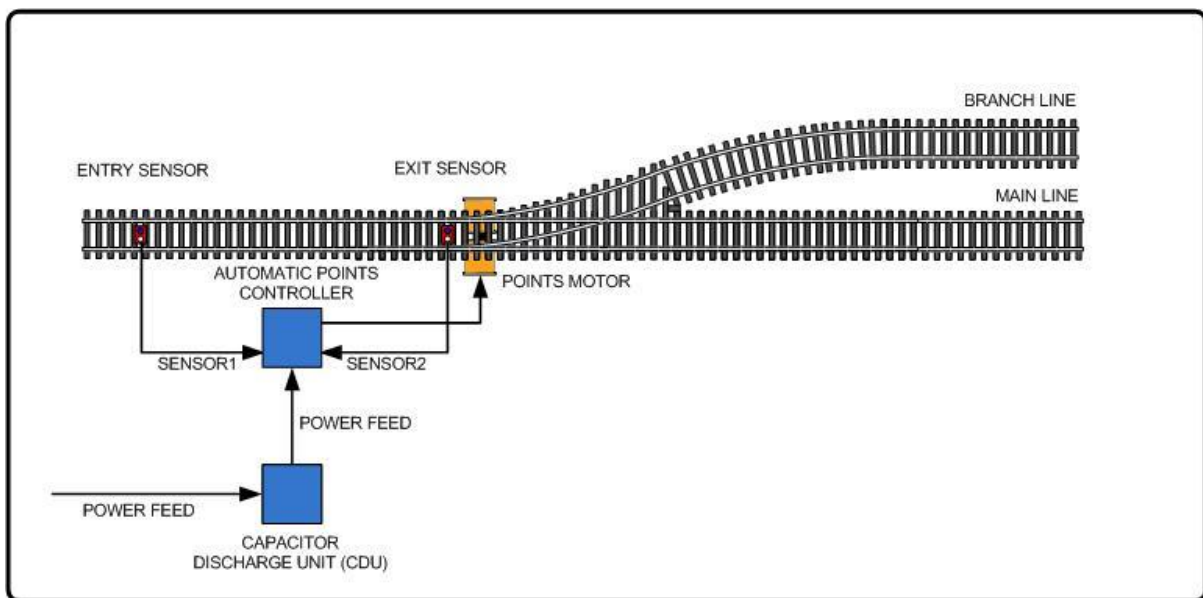

The sensor located at the points, detects the end of the train, and allows the points module to change the points if required. Until the train has cleared the points, the points remain locked in position.

# Operation with Facing Points and Trailing Points

Using a pair of modules, trains can be routed onto branch line and then automatically back onto a main line.

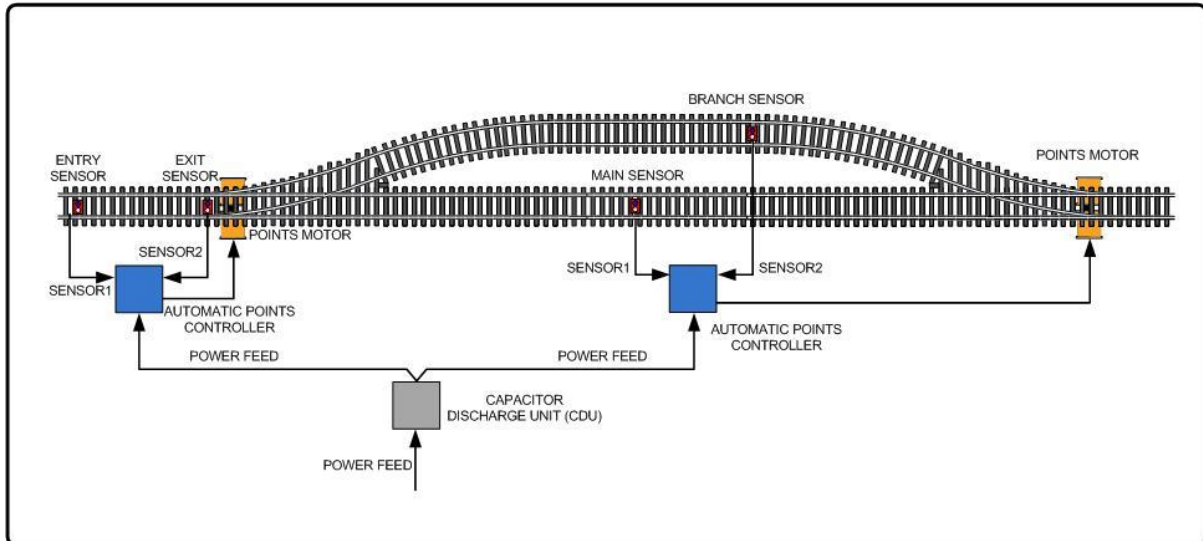

## Wiring

Every layout requires one Capacitor Discharge Unit (CDU) which is used to feed high current pulses to the points motors when they are required to switch.

The points module connects to the output of the CDU (to provide power to operate the points), and also to the power supply which feeds the CDU (to provide power to the points module electronics).

One CDU can be shared amongst many points control modules and can also feed manually operated points.

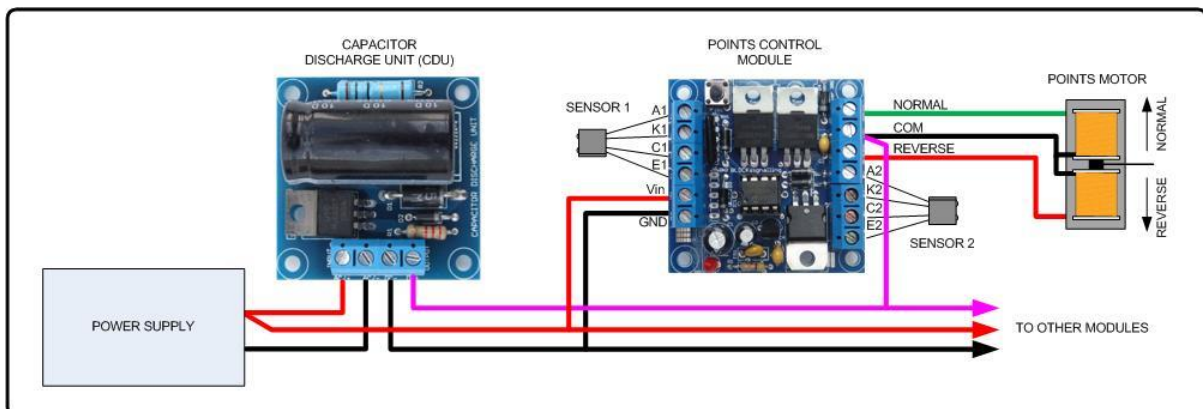



## **Programming the Mode**

There a number of parameters which can be changed to alter the operation of the module to add great flexibility and variety in the way that it can be used. In general, only whether the points are to be operated in a facing or trailing mode needs to be selected when first using the module. The remaining parameters can be adjusted at a later time if needed.

To change the mode, switch off the power to the module and hold down the Push Button. Apply the power and continue holding the Push Button until 2 flashes of the led are seen. At this point, release the button. You will see a long flash of five seconds.

The led will begin flashing again. When you have seen 2 flashes (trailing points) or 3 flashes (facing points), press the button. You will see a long flash of five seconds and then 10 rapid flashes. The programming is then complete and the module will restart. If you make a mistake programming, simply repeat the process.

## **Setting the Points Position on Boot**

When the power to the module is switched on, it can be selected to switch the points to normal, or reverse, or to drive them in the direction they were last set when the power was turned off.

## **Setting the Route Selection**

When operating in facing point mode, trains will automatically be routed to to the branch, either regularly or randomly.

The proportion is set by the Branch Line Selection Ratio.

A setting of 1 will send 1 in 16 trains to the branch.

A setting of 2 will send 1 in 8 trains to the branch.

A setting of 3 will send 1 in 4 trains to the branch.

A setting of 4 will send 1 in 2 trains to the branch.

The regular and random settings will send an equal number of trains to the branch line, the difference being that the random setting sends them to the branch line in a random order and the regular setting sends them to the branch line in a predictable order.

## **Setting the Sensor Type**

The module can operate with the following types of sensor:

1. Infra-Red
2. Push Buttons and Reed Switches
3. Switches
4. Hall Sensors
5. Photosensors (future option)

## **Setting the Points Drive Duration**

The duration that the outputs operate to drive the points motors is adjustable in 200ms steps. The default setting is 5, resulting in each output being driven for 1 second to move the points.

## **Setting the Unlock Time**

When operating with facing points, the points action is triggered by Sensor 1.

Once sensor 1 has been triggered, the module prevents operation of the points until the train has cleared the points, confirmed by Sensor 2.

The points are only unlocked after Sensor 2 has detected a train AND then Sensor 2 has also detected the train has passed and cleared Sensor 2.

The points can then be retriggered by Sensor 1.

The duration that Sensor 2 must confirm the absence of a train can be adjusted using the Unlock Time. The Unlock Time can be set from 1 to 20 seconds with the default is 4 seconds.

## **Selecting Retriggering**

When retriggering is selected, each time the inputs are triggered, the points are operated, even if they are already in the correct position. If retriggering is disabled, then the points are only operated if they are currently in the wrong position.

## **Selecting Detection Direction and Detection Threshold**

These are settings for future options using photosensors and do not need to be adjusted on the current module which does not have the option to use photosensors at present.

# Programming Options

The following diagram shows the programming options available:

